

DOOR STOPS AND CUSHIONS FOR BY-PASSING DOORS

639 Center Stop

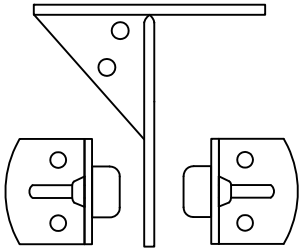

2 Bumpers supplied with Stop

On three door installations 639 center Stop may be mounted on either left or right hand edge of center door. Only one bumper is used.

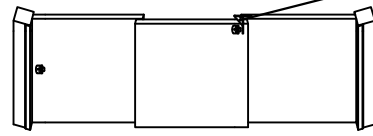

4 Door installation with 639 Center Stop. (2 bumpers used)

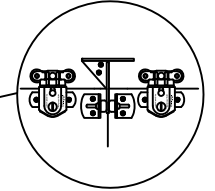
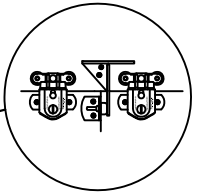
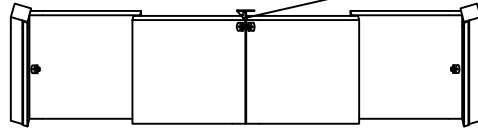

880 Door Stop

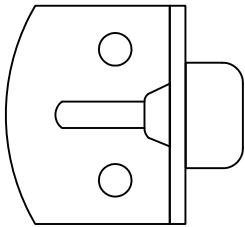

Limits sliding action of door so fingers cannot get pinched when rear door is fully opened. Keeps flush pull on rear door accessible.

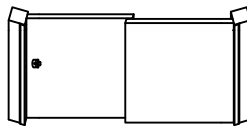
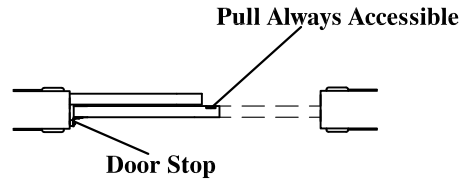

2 Door Installation with 880 Door Stop

885 Door Cushions

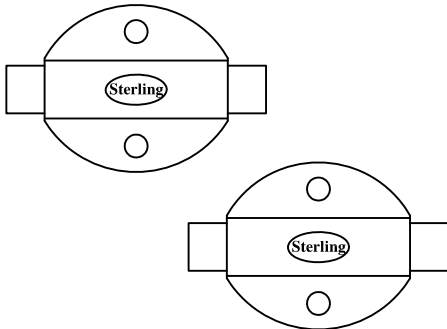

For maximum quietness use two cushions per door. Also on three and four door installations.

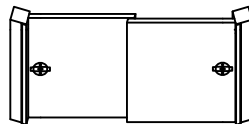

2 Door Installation with two 885 Door cushions

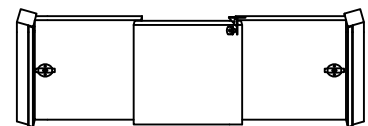

3 Door Installation with two 885 Door cushions and 639 Center Stop (Only one bumper used)

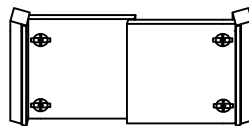

2 Door Installation with four 885 Door cushions

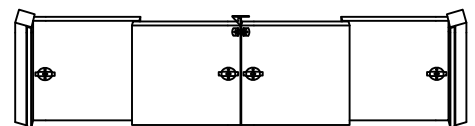

4 Door Installation with four 885 Door cushions and 639 Center Stop. Mount two 885 Door Cushions on meeting doors as shown.

Absorb shock and prevent slamming noise when doors are closed. Limits sliding action when rear doors are opened so fingers cannot get pinched in pull. Keeps flush pull on rear door accessible.

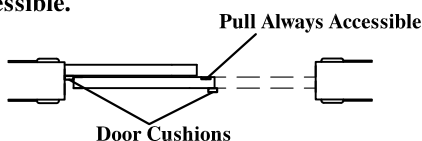

DIRECTIONS FOR INSTALLING 600 SERIES HARDWARE

WITH DOOR GUIDE

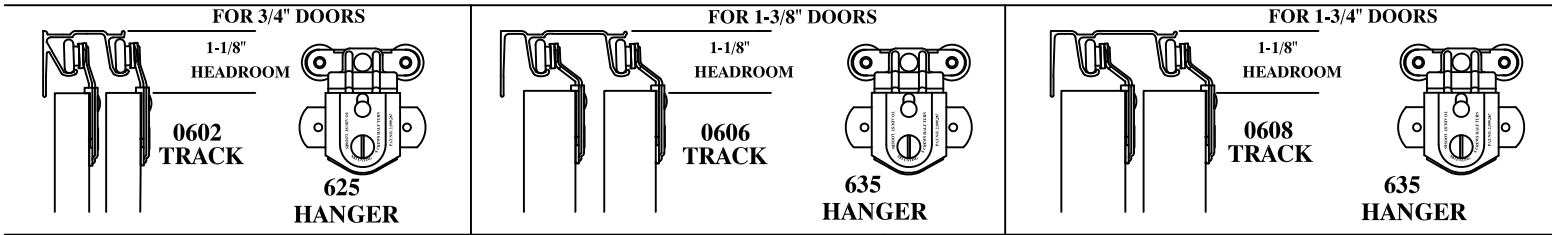

STEP 1 FRAME - FINISH OPENING

Opening can be standard height. Trim doors to allow 1-1/8" headroom for hardware and about 1/2" clearance between door and floor. Or, if preferred, trim door to standard height and make opening height..

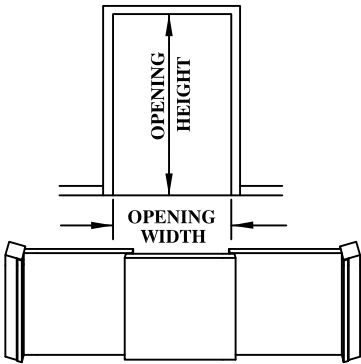

OPENING WIDTH FOR 3 DOORS
3 Door Widths Minus 2" Overlap

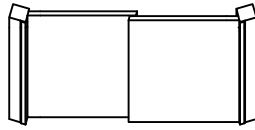

OPENING WIDTH FOR 2 DOORS
2 Door Widths Minus 1" Overlap

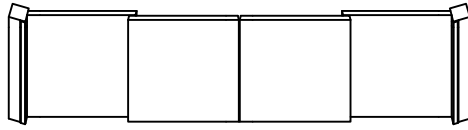

OPENING WIDTH FOR DOORS
4 Door Widths Minus 2" Overlap

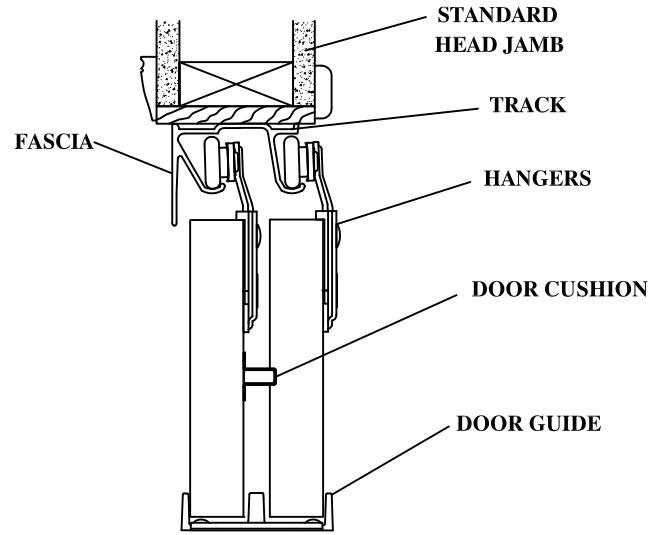

STEP 2 ATTACH TRACK

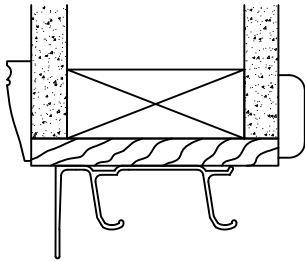

STEP 4 DOOR GUIDE

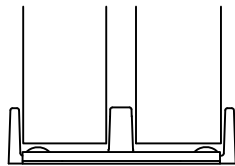

Move doors to one side. Set guide on floor as shown. Drill hole and insert screw. Move doors to other side. drill hole and insert other screw.

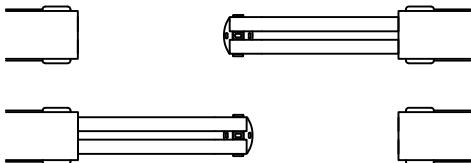

4239-FRONT

STEP 3 ATTACH HANGERS TO DOORS

MICRO CAM HANGERS

MOUNTING SCREWS

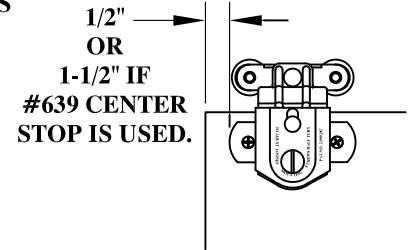
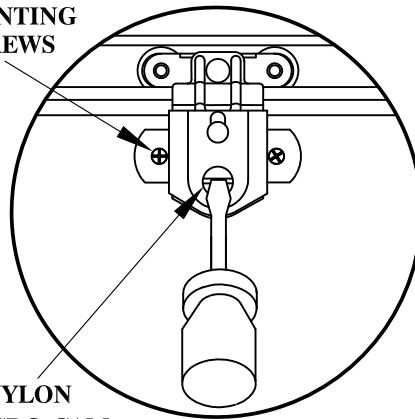

TO PLUMB DOOR

- A. LOOSEN MOUNTING SCREWS HALF TURN.
- B. TURN NYLON CAM WITH SCREWDRIVER.
- C. TIGHTEN SCREWS.

