

# INSTALLATION INSTRUCTIONS

## 1. Check Doorway Size:

Finished Doorway Width for 2-Door = 2 Door Widths less 1" (24.4 mm)  
 Finished Doorway Width for 3-Door = 3 Door Widths less 2" (50.8 mm)  
 Finished Doorway Height = 2 Door Height + 1-3/4" 44.4mm

### Narrow Track

(1-1/2" (38.1mm) center to center)  
 Use "A" and "B" Hangers

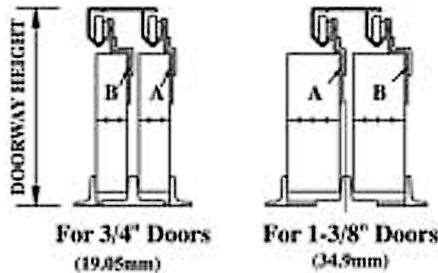

### Wide Track

(1-3/4" (44.4mm) center to center)  
 Use "B" Hangers on 1-3/8" (34.9mm) Doors

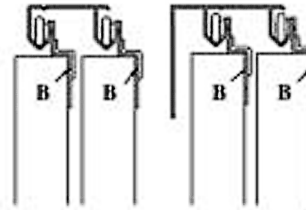

## 2. Mount Track and Attach Hangers

**NOTE:** In sets containing both "A" and "B" hangers, when hanging 1-3/8" (34.9mm) thick doors use "A" hangers on frontdoor and "B" hangers on rear door. For 3/4" (19.05mm) thick doors, use "B" hangers on front door and "A" hangers on rear door.

### Mount Hangers

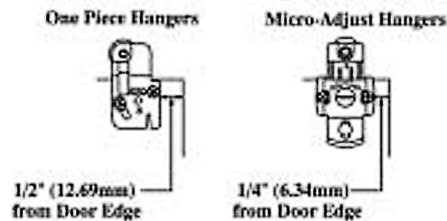

## 3. Hang Doors

Mount rear door first by tilting door back and resting hangers on rear rail.

## 4. Adjust Door to Square with Sides of Doorway.

**ONE PIECE HANGERS**  
 Loosen two mounting screws, rotate hanger with screwdriver and tighten screws.

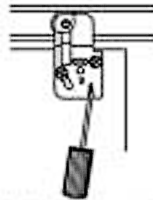

**MICRO-ADJUST HANGERS**  
 Loosen two mounting screws, turn nylon cam with screwdriver, tighten screws.

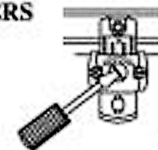

## 5. Install Door Guide(s) where Doors overlap.

(Adjustable Style)



(Fixed Style)



## 6. Install Stops (optional) and Pulls

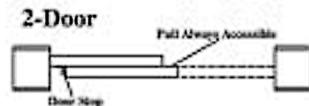

8621-S  
9-06

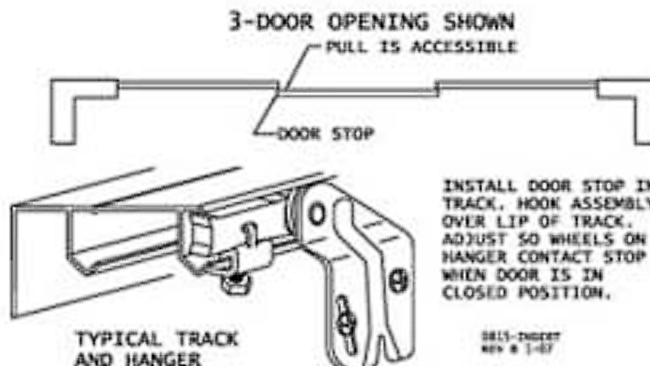

INSTALL DOOR STOP IN TRACK. HOOK ASSEMBLY OVER LIP OF TRACK. ADJUST SO WHEELS ON HANGER CONTACT STOP WHEN DOOR IS IN CLOSED POSITION.

8615-TRGSET  
REV. 6-1-07